

EST.

1992



F I R E P L A C E S



PANTHERM



PANAQUA



PANTECH B



PANTECH JOY



PANTECH EVO PREMIUM

DINAMIKA
DYNAMICS

TAPASZTALAT
EXPERIENCE

MEGBÍZHATÓSÁG
RELIABILITY



if. Haigli Ferenc
Termelési Igazgató
Production Manager

A handwritten signature in black ink, appearing to be 'if. Haigli Ferenc', written over a yellow and orange geometric background.

Haigli Ferenc
Ügyvezető
Manager

A handwritten signature in black ink, appearing to be 'Haigli Ferenc', written over an orange and red geometric background.

Haigli Árpád
Értékesítési Vezető
Sales Manager

A handwritten signature in black ink, appearing to be 'Haigli Árpád', written over a red and orange geometric background.



TISZTA ENERGIA / PURE ENERGY

A fa teljes élete alatt annyi szén-dioxidot köt meg, mint amennyit az elégetés során kibocsájt. Ezért a fatüzelés megújuló és környezetbarát.

Through the lifetime of timber binds as much Carbon dioxide as generated through the incineration.

When the tree falls and become rotten as much Carbon dioxide generates as through burning.

We can conclude that when firing in fireplace is a renewable energy while its environment friendly and clear.

JELMAGYARÁZAT

Symbol explanation



Teljesítmény
Output



Szélesség
Width



Súly
Weight



Úrtartalom
Tonnage



Hatásfok
Efficiency



Hatásfok hődobbal
Efficiency with heat reclaimers



Fahasáb maximális hosszúság
Wooden blocks max length



Zárt égéstér
Sealed Chamber



A víz és levegőoldali teljesítmény
Water and air side performance



Külső levegő bevezetés
Exterior air supply



CO kibocsátás
CO emissions



Szükséges kéményhuzat-teljesítmény
Required chimney draft output



Szállópor koncentrátum
Fly powder Concentrate



NERO sík üveg (fekete szegélyes üveg)
NERO flat glass (black border glass)



Vízűtő rendszer
Water cooling system



Lábazat
Footing



Elérhető feltolható ajtóval
OptionLD modul (lifted door)



Magasító láb
Elevating footing

PANTHERM

Tűztér család / Firebox Family

	8-19
PanTherm Optimum 62	9
PanTherm Optimum 68	10
PanTherm 62	11
PanTherm 68	12
PanTherm 68 LD	13
PanTherm Panorama	14
PanTherm Prizma Nero	15
PanTherm 69 CG L	16
PanTherm 69 CG R	17
PanTherm 75 CG L	18
PanTherm 75 CG R	19

PANAQUA

Vízköpenyes Tűztér család /
Water-Jacketed Firebox Family

	20-40
PanAqua mini	22
PanAqua 15 KW	23
PanAqua 20 KW	24
PanAqua 20 KW TUNNEL	25
PanAqua 25 KW	26
PanAqua 30 KW	27
PanAqua 30 KW TUNNEL	28
PanAqua 75 CG L	30
PanAqua 75 CG R	31
PanAqua 110	32
PanAqua 110 TUNNEL	33
PanAqua 68 EVO	34
PanAqua 80 EVO	35
PanAqua 110 EVO	36
PanAqua 80 EVO LD	37
PanAqua 100 EVO LD	38
PanAqua 130 EVO LD	39
PanAqua EVO d160	40
Kályha / Stove	

PANTECH B

Tűztér család / Firebox Family

	42-53
PanTech 45 B CG	44
PanTech 60 B	45
PanTech B CG L	46
PanTech B CG R	47
PanTech 60 BU	48

PanTech 70 BU	49
PanTech 68 B	50
PanTech 69 B CG L	52
PanTech 69 B CG R	53
PanTech 75 B CG L	54
PanTech 75 B CG R	55
PanTech 80 B	56

PANTECH MOBIL

Tűztér család / Firebox Family

	57-66
PanTech 60 B Mobil	58
black / white 1+2	
PanTech 60 B Mobil	59
black / white 2+2	
PanTech 60 B CG R Mobil	60
black / white 1+2	
PanTech 60 B CG R Mobil	61
black / white 2+2	
PanTech 60 B CG L Mobil	62
black / white 1+2	
PanTech 60 B CG L Mobil	63
black / white 2+2	
PanTech 60 B U Mobil	64
black / white 1+2	
PanTech 60 B U Mobil	65
black / white 2+2	

PANTECH JOY

Tűztér család / Firebox Family

	68-74
PanTech 80 JOY CG LD L	70
PanTech 80 JOY CG LD R	71
PanTech 80 JOY U LD	72
PanTech 80 JOY V LD	73
PanTech 100 JOY LD	74

PANTECH EVO PREMIUM

Tűztér család / Firebox Family

	76-95
PanTech 68 EVO	78
PanTech 68 EVO TUNNEL	79
PanTech 80 EVO	80
PanTech 80 EVO TUNNEL	81
PanTech 80 EVO LD	82
PanTech 80 EVO LD TUNNEL	83

PanTech 90 EVO CG LD L	84
PanTech 90 EVO CG LD R	85
PanTech 100 EVO LD	86
PanTech 100 EVO LD TUNNEL	87
PanTech 100 EVO U LD	88
PanTech 100 EVO V LD	89
PanTech 110 EVO	90
PanTech 110 EVO TUNNEL	91
PanTech 130 EVO LD	92
PanTech 130 EVO LD TUNNEL	93
PanTech 160 EVO LD	94
PanTech 200 EVO LD	95

PANTECH

Tűztér család / Firebox Family

	96-99
PanTech CLASSIC 95	96
PanTech CLASSIC 110	97
PanBox 68	98
PanBox 110	99

ELEKTROMOS TŰZTEREK

Electrical fireplaces

	98-100
--	--------

HŐDOBOK

Heat reclaimers

	101-104
Hődob 150	102
Hődob 200	103
Vizes hődob Mini és Maxi • Water Heat reclaimer Mini and Maxi	104

KIEGÉSZÍTŐK

Accessories

	106-109
--	---------

TECHNICAL TŰZTEREK

A tűz varázsa otthonában

Feladatunk, hogy minél magasabb minőségű és hosszú élettartamú termékekkel tudjuk kiszolgálni vevőinket, ezért rendelkeznek tűztereink egyedülállóan nagy falvastagsággal, igen magas hőleadó felülettel, és az előírtnál jobb anyagminőséggel. Adott kategóriában a legnagyobb súllyal rendelkeznek tűztereink, melyek a legszigorúbb és legújabb TÜV európai normás vizsgálatokon az elérhető legjobb minősítést kapták. Minden Technical tűztér magyar termék. A kandallógyártásban szerzett 28 év tapasztalatunk az 5 és 7 év garanciás tűztereink kiváló minőséget és megbízhatóságot garantálnak. Központi fűtésre köthető vizes és légfűtő tűztereink a megfelelő kiegészítő alkalmazásával 80% feletti hatásfok leadására képesek, ami az elérhető maximum. Nem takarékoskodtunk a felhasznált anyagok minőségével, vastagságával valamint az alapos és hosszú mérnöki fejlesztőmunkával sem. További információval szívesen állunk rendelkezésükre bemutatótermünkben illetve telefonon. Termékválasztékunk folyamatosan bővül.

TECHNICAL FIREBOXES

Magic of fire at home

Our objective is to offer high quality and long lasting products to our customers. For this reason our products have uniquely thick walls, big heat dissipation surface and better quality of materials than prescribed. In its category these fireboxes are the number ones and received the highest qualification in a stricter and latest examinations. All Technical fireboxes are Hungarian products. We guarantee the excellent quality and reliability by 28 year experience at firebox manufacturing, 5 to 7 year guarantee of some of our fireboxes. Waterjacket and air heater fireboxes, with a help of the appropriate accessories, are able to function with 80 % of efficiency, which is the maximum that can be attained. We don't economize on high quality materials, their thickness or thorough and long engineering. We are at your disposal for further information at our showrooms or by phone. Our product scale is broadening.



PANTHERM

Tűztér család / Firebox family



Teljesítmény és hatásfok:

A kiváló hatásfok, teljesítmény és környezettudatos kivitel érdekében, nagy hőleadó felületek, Eco és EcoPlus égésvezérlések. A huzatszabályzó pillangószelep alapfelszereltség minden típus esetében, kivéve egyes modelleknél.

Élettartam:

Hosszú élettartalmú, robusztus, vastagfalú kivitelek. 28 év tapasztalata és alapos mérnöki fejlesztő munka eredménye.

Design:

Maximális üvegfelületek, hagyományos és NERO üvegezéssel, akár minden oldalról üveges, trapéz és íves ajtó variálhatóságával.

ECO rendszer / system:

Harmadlagos levegőellátást biztosít, mely lehetővé teszi a füstgázokban visszamaradó, éghető gázok elégetését, növeli a hatásfokot és a teljesítményt, továbbá az üzemeltetés is környezetbarát.

It assures extra air supply, that allows the burning of flue gases remaining from the exhaust fumes, raises the efficiency, the performance and the operation is environmentally friendly.

EcoPlus rendszer / system:

Tartalmazza az ECO utánégető rendszert, azzal a plusz szolgáltatással, amely lehetővé teszi a tűztér teljes, fokozatmentes égés szabályzását külső levegő ellátással.

It contains the Eco system with an extra service that assures complete and ungraded damper in the fireboxes with external air supply.

Efficiency and performance:

To obtain excellent efficiency, performance and environmentally friendly implementation, fireboxes contain big heat dissipation surfaces, Eco and EcoPlus system. The baffle valve is the part of all types of fireboxes.

Lifetime:

The long lifetime, robust and thick wall constructions are the results of the 28 year experience and thorough engineering.

Desing:

Big glass surfaces, with traditional or NERO glazing. All sides can be glass, with trapezoid or cambered glass.

PANTHERM

Szerkezet / Structure 62, 68



1 Füsttömeg szabályozás. Fontos a füsttömeg kiáramlásának torlasztása az égésidő és a hatásfok növelésének érdekében. Regulation of the smoke crowd. To reach the improving burning time and the efficiency with the help of the blocking of the exhaust of the smoke is important

2 Lángterelő
Flame deflector

3 Secunder levegő, légfüggöny
Secondary air, air curtain

4 Hőleadó borda
Heat rejection panel

5 Rostély
Grate

6 Hamufiók
Ash tray

7 Fafogó
Timber holding

PANTHERM

Optimum 62



**GARANCIA
GUARANTEE**

TÜV
CERTIFICATIONS



8 kW



62 cm



100 kg



74 %



79 %



35 cm



Option



Lábazat
/ Legs
Option



14-16 PA



NERO Design Option



150

flue base
construction
fűtőcsőnk
átmérő

PANTHERM

Optimum 68



10 kW



68 cm



110 kg



74 %



78 %



40 cm



Lábazat
/ Legs
Option



14-16 PA

~~Ø 200~~
flue base
construction
fűtőcsőnk
átmérő

~~Ø 150~~
flue can be
ordered
válsztható
fűtőcsőnk
átmérő

PANTHERM

62



**GARANCIA
GUARANTEE**

**TÜV
CERTIFICATIONS**



13 kW



62 cm



125 kg



76 %



14-16 PA



81 %



35 cm



Option



Lábazat
/ Legs
Option



**NERO
Design**



**NERO
Option**

- Minden típushoz rendelhető
- All types available



Left



Right

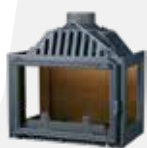

Left and Right



Four Glasses



TUNNEL



TUNNEL left



TUNNEL right



ECO



ECO +



Convectional



150
flue base
construction
fűstcsanak
átmérő

200
flue can be
ordered
választható
fűstcsanak
átmérő

PANTHERM

68



**GARANCIA
GUARANTEE**

**TÜV
CERTIFICATIONS**



15 kW



68 cm



135 kg



76 %



14-16 PA



82 %



40 cm



Option



Lábazat
/ Legs
Option



**NERO
Design**



**NERO
Option**

- Minden típushoz rendelhető
- All types available



Left



Right



Left and Right



Four Glasses



TUNNEL



TUNNEL left



TUNNEL right



ECO



ECO +



Convectional

200
flue base
construction
fűtőcsanak
átmérő

150
flue can be
ordered
választható
fűtőcsanak
átmérő

PANTHERM

68 LD



15 kW



68 cm



215 kg



76 %



14-16 PA



82 %



40 cm



Option



Lábazat
/ Legs
Option



NERO
Standard



200
flue base
construction
fűtőcsőnk
átmérő

PANTHERM

Panorama



15 kW



68 cm



140 kg



76 %



82 %



40 cm



Option



Lábazat /
Legs
Option



14-16 PA



Left



Right



Left and Right



Four Glasses



TUNNEL



200

flue base
construction
fűtcsanak
átmérő



TUNNEL left



TUNNEL right



ECO



ECO +



Convectonal



150

flue can be
ordered
választható
fűtcsanak
átmérő

PANTHERM

Prizma Nero



15 kW



68 cm



142 kg



76 %



82 %



40 cm



Option



Lábazat /
Legs
Option



14-16 PA



Left



Right



Left and Right



Four Glasses



TUNNEL

200
flue base
construction
fűtőcsőnk
átmérő

150
flue can be
ordered
választható
fűtőcsőnk
átmérő



TUNNEL left



TUNNEL right



ECO



ECO +



Convictional

 TECHNICAL

PANTHERM

69 CG L



GARANCIA
GUARANTEE

TÜV
CERTIFICATIONS



ECO



ECO +



Convectional



13 kW



69 cm



121 kg



76 %



81 %



40 cm



Option



Lábazat
/ Legs
Option



14-16 PA



NERO
optional

 **200**
flue base
construction
fűtcsonk
átmérő

 **150**
flue can be
ordered
választható
fűtcsonk
átmérő

PANTHERM

69 CG R



ECO



ECO +



Convectional



13 kW



69 cm



121 kg



76 %



81 %



40 cm



Option



Lábazat
/ Legs
Option



14-16 PA



NERO
optional

 **200**
flue base
construction
fűtőcsanak
átmérő

 **150**
flue can be
ordered
választható
fűtőcsanak
átmérő

PANTHERM

75 CG L



ECO

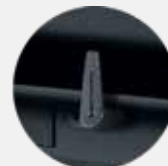

ECO +



Convectional

A képen látható tüztér NERO üveg opciót tartalmaz. / NERO glazing in the picture is optional.



15 kW



75 cm



129 kg



76 %



82 %



40 cm



Option



Lábazat
/ Legs
Option



14-16 PA



NERO
optional

200
flue base
construction
füstcsanak
átmérő

PANTHERM

75 CG R



ECO



ECO +



Convectional

A képen látható tűztér NERO üveg opciót tartalmaz. / NERO glazing in the picture is optional.



15 kW



75 cm



129 kg



76 %



82 %



40 cm



Option



Lábazat
/ Legs
Option



14-16 PA



NERO
optional

200
flue base
construction
füstcsanak
átmérő

PANAQUA

Vízköpenyes tűztér család
Water-Jacketed firebox family



Teljesítmény és hatásfok:

Az elérhető legmagasabb hatásfok, teljesítmény és környezettudatos kivitel. Nagy hőleadó felületek és 80% feletti hatásfok. Panaqua EVO: levegő előmelegítő rendszerrel.

Élettartam:

Hosszú élettartamú, robusztus, vastagfalú kivitelek. 28 év tapasztalata és alapos mérnöki fejlesztő munka eredménye.

Design:

Maximális üvegfelület, modern esztétikus kialakítás, tűztérhez simuló kezelőszervek.

Efficiency and performance:

To obtain excellent efficiency, performance and environmentally friendly implementation, fireboxes contain big heat dissipation surfaces, Eco and EcoPlus system. The baffle valve is the part of all types of fireboxes. Panaqua EVO: with preheater system.

Lifetime:

The long lifetime, robust and thick wall constructions are the results of the 28-year experience and thorough engineering.

Desing:

Big glass surfaces, modern, stunning design, practical output.

PANAQUA EVO

Szerkezet / Structure

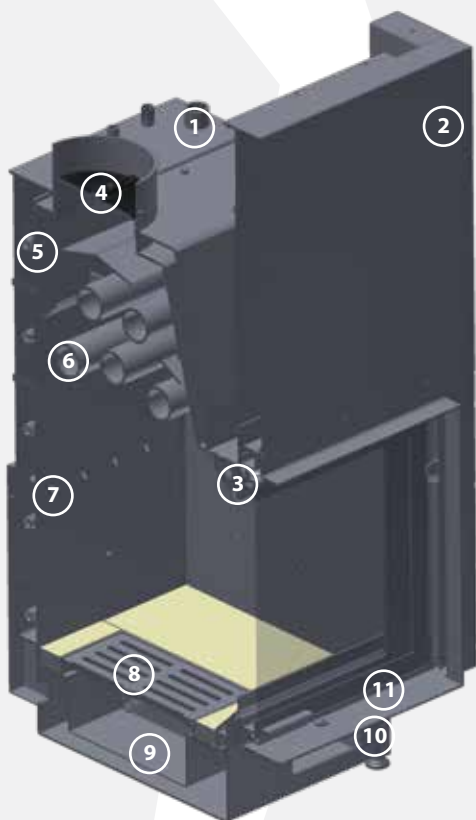

1 Bekötő csatlakozások
Accessing connectors

2 Ajtóemelő szerkezet
Door lifting structure

3 Secunder levegő, légfüggöny
Secondary air, air curtain

4 Füsttömeg szabályozás. Fontos a füsttömeg kiáramlásának torlasztása az égésidő és a hatásfok növelésének érdekében.
Regulation of the smoke crowd. To reach the improving burning time and the efficiency with the help of the blocking of the exhaust of the smoke is important

5 Visszahűtő
Intercooler

6 Vízcövek- vízköpeny
Water tubes – water jacket

7 Harmadlagos levegő
Tertiary air

8 Rostély
Grate

9 Hamuláda
Ash box

10 Szintezőláb
Leveling feet

11 Levegő szabályzókar
Air controlling lever

 TECHNICAL

PANAQUA

Mini



GARANCIA
GUARANTEE

TÜV
CERTIFICATIONS

Options
Opciók

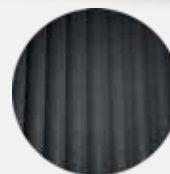

Ajánlott Vermikulit bélésel
Option Vermiculite Linings



7-12 KW



33 l



68 cm



110 kg



>76 %



40 cm



Standard



Visszahűtő
rendszer
/ Safety
system



Lábazat
/ Legs
Option



14-16 PA



9 kW /
3 kW

 **150**
flue base
construction
fűtőcsanak
átmérő

 TECHNICAL

PANAQUA

15 KW



GARANCIA
GUARANTEE

TÜV
CERTIFICATIONS

Options
Opciók



Ajánlott Vermikulit béléssel
Option Vermiculite Linings



9-15 KW



39 l



62 cm



174 kg



80 %



35 cm



Standard



Visszahűtő
rendszer
/ Safety
system



Lábazat
/ Legs
Option



14-16 PA



12 kW /
3 kW

Ø **150**
flue base
construction
fűtőcső
átmérő

 TECHNICAL

PANAQUA

20 KW



GARANCIA
GUARANTEE

TÜV
CERTIFICATIONS

Options
Opciók

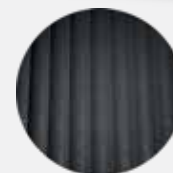

Ajánlott Vermikulit béléssel
Option Vermiculite Linings



12-20 kW



42 l



68 cm



189 kg



80 %



40 cm



Standard



Visszahűtő
rendszer
/ Safety
system



Lábazat
/ Legs
Option



14-16 PA



16 kW /
4 kW

 **200**
flue base
construction
fűtőcsanak
átmérő

Options Opciók



Ajánlott Vermikulit béléssel
Option Vermiculite Linings



12-20 kW



36 l



68 cm



210 kg



80 %



40 cm



Standard



Visszahűtő
rendszer
/ Safety
system



Lábazat
/ Legs
Option



14-16 PA



16 kW /
4 kW

 **200**
flue base
construction
fűtőcsanak
átmérő

 TECHNICAL

PANAQUA

25 KW



GARANCIA
GUARANTEE

TÜV
CERTIFICATIONS

Options
Opciók

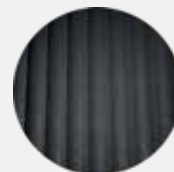

Ajánlott Vermikulit béléssel
Option Vermiculite Linings



15-25 kW



51 l



71 cm



215 kg



80 %



45 cm



Standard



Visszahűtő
rendszer
/ Safety
system



Lábazat
/ Legs
Option



14-16 PA



20 kW /
5 kW

 **200**
flue base
construction
fűtőcső
átmérő

Options Opciók

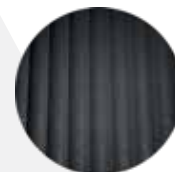

Ajánlott Vermikulit béléssel
Option Vermiculite Linings



18-30 kW



55 l



80 cm



238 kg



80 %



55 cm



Standard



Visszahűtő
rendszer
/ Safety
system



Lábazat
/ Legs
Option



14-16 PA



24 kW /
6 kW

200
flue base
construction
fűtőcső
átmérő

 TECHNICAL

PANAQUA

30 KW TUNNEL



GARANCIA
GUARANTEE

TÜV
CERTIFICATIONS

Options

Opciók

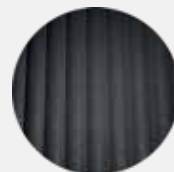
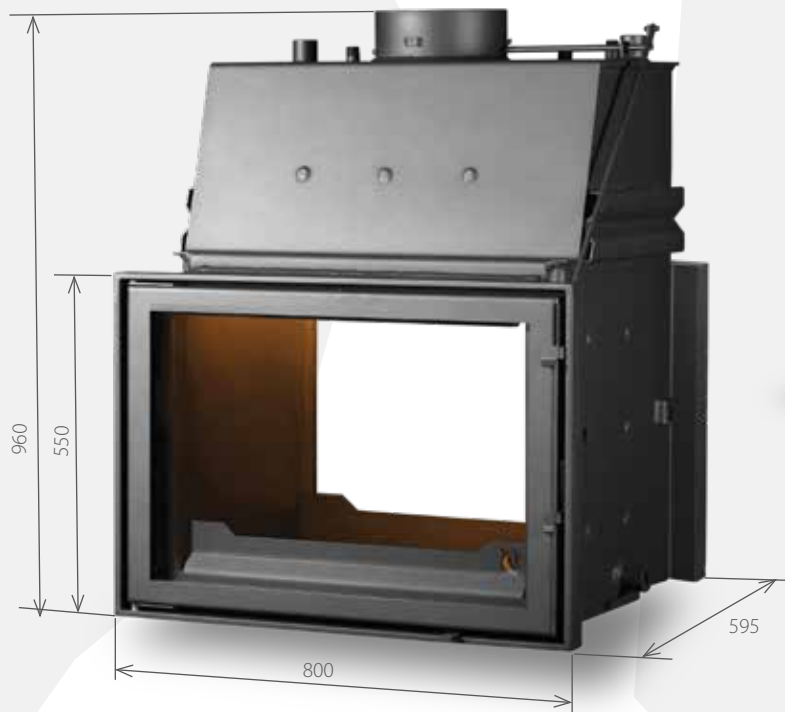

Ajánlott Vermikulit béléssel
Option Vermiculite Linings



18-30 kW



45 l



80 cm



253 kg



80 %



55 cm



Standard



Visszahűtő
rendszer
/ Safety
system



Lábazat
/ Legs
Option



14-16 PA



21 kW /
9 kW

 **200**
flue base
construction
fűtőcső
átmérő



TECHNICAL

PANAQUA

75 CG L



**GARANCIA
GUARANTEE**

**TÜV
CERTIFICATIONS**

Options
Opciók

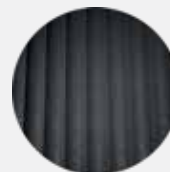
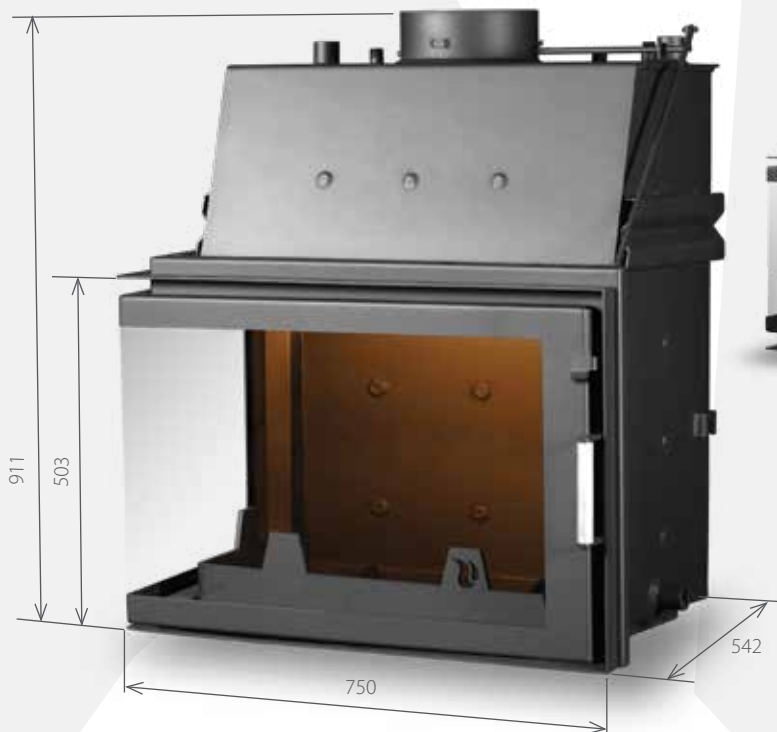

Ajánlott Vermikulit béléssel
Option Vermiculite Linings



**NERO
Design**



14-24 kW



43 l



75 cm



209 kg



80 %



45 cm



Standard



Visszahűtő
rendszer
/ Safety
system



Lábazat
/ Legs
Option



14-16 PA



NERO
Option



18 kW /
6 kW

200
flue base
construction
fűtőcsőnk
átmérő

Options
Opciók

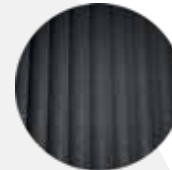
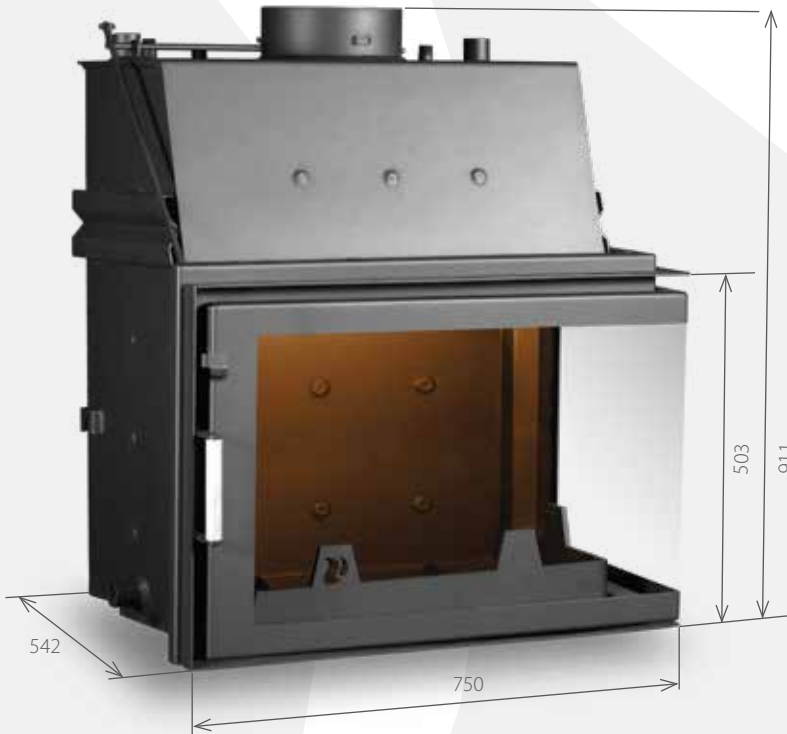

Ajánlott Vermikulit bélésel
Option Vermiculite Linings



NERO
Design



14-24 kW



43 l



75 cm



209 kg



80 %



45 cm



Standard



Visszahűtő
rendszer
/ Safety
system



Lábazat
/ Legs
Option



14-16 PA



NERO
Option



18 kW /
6 kW

Ø **200**

 TECHNICAL

PANAQUA

110



GARANCIA
GUARANTEE

TÜV
CERTIFICATIONS

Options
Opciók

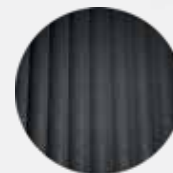

Ajánlott Vermikulit béléssel
Option Vermiculite Linings



18-30 kW
24-40 kW



72/75 l



110 cm



300/310 kg



80 %



70 cm



Standard
Visszahűtő
rendszer
/ Safety
system



14-16 PA



21 kW /
9 kW

30kW ~~Ø~~ **200**
flue base
construction
fűstcsonk
átmérő

40kW ~~Ø~~ **250**
flue can be
ordered
választható
fűstcsonk
átmérő

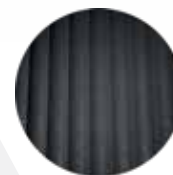
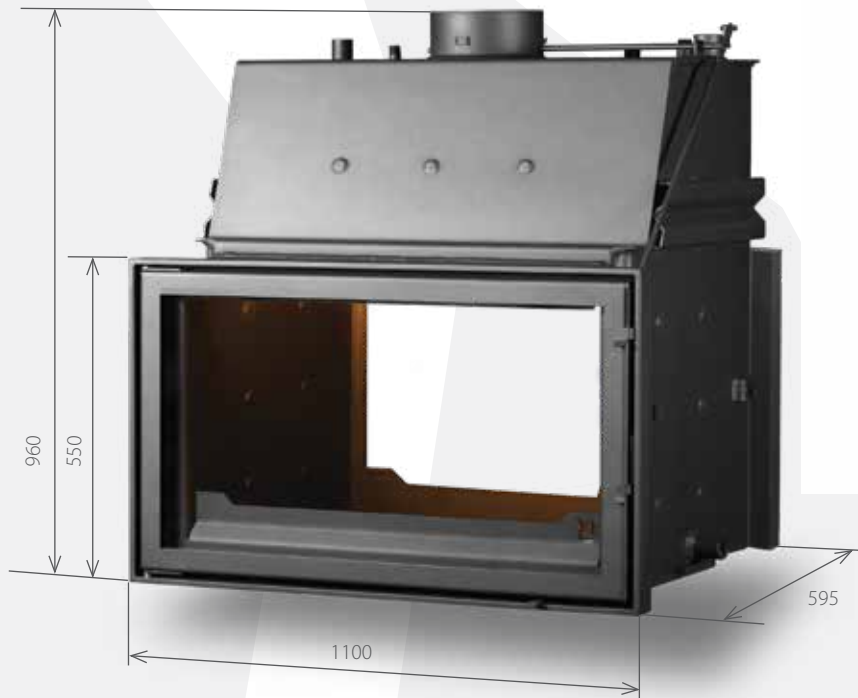

Ajánlott Vermikulit béléssel
Option Vermiculite Linings



18-30 kW



60 l



110 cm



329 kg



80 %



70 cm



Standard



Visszahűtő
rendszer
/ Safety
system



Lábazat
/ Legs
Option



14-16 PA



21 kW /
9 kW

 **200**
flue base
construction
fűtőcső
átmérő



**GARANCIA
GUARANTEE**

Options
Opciók

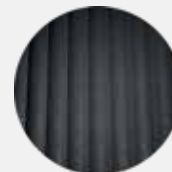

Ajánlott Vermikulit béléssel
Option Vermiculite Linings



12-20 kW



47 l



68 cm



222 kg



> 80 %



40 cm



Standard



Zárt égéster
Sealed Chamber



Visszahűtő
rendszer
/ Safety
system



0,09 %



14-16 PA



25
mg/Nm³



NERO
Standard



16 kW /
4 kW



200
flue base
construction
fűtőcsanak
átmérő

PANAQUA

80 EVO



**GARANCIA
GUARANTEE**

Options
Opciók



Ajánlott Vermikulit béléssel
Option Vermiculite Linings



18-30 kW



56 l



80 cm



260 kg



> 80 %



55 cm



Standard



Zárt égéstér
Sealed Chamber



Visszahűtő
rendszer
/ Safety
system



0,09 %



14-16 PA



25
mg/Nm³



NERO
Standard



16 kW /
4 kW



200
flue base
construction
fűtőcsanak
átmérő

PANAQUA

110 EVO



**GARANCIA
GUARANTEE**

Options
Opciók

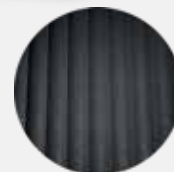

Ajánlott Vermikulit béléssel
Option Vermiculite Linings



18-30 kW



74 l



110 cm



341 kg



> 80 %



70 cm



Standard



Zárt égéster
Sealed Chamber



Visszahűtő
rendszer
/ Safety
system



0,09 %



14-16 PA



25
mg/Nm³



NERO
Standard



24 kW /
4 kW



200
flue base
construction
fűtőcsanak
átmérő



**GARANCIA
GUARANTEE**

Options
Opciók



Ajánlott Vermikulit béléssel
Option Vermiculite Linings



12-20 kW



47 l



84 cm



276 kg



> 80 %



40 cm



Standard



Zárt égéstér
Sealed Chamber



Visszahűtő
rendszer /
Safety
system



0,09 %



14-16 PA



25
mg/Nm³



NERO
Standard



16 kW /
4 kW



200
flue base
construction
fűtőcsanak
átmérő

PANAQUA

100 EVO LD



**GARANCIA
GUARANTEE**

Options
Opciók

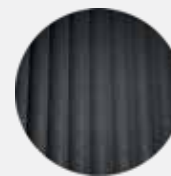

Ajánlott Vermikulit béléssel
Option Vermiculite Linings



18-30 kW



56 l



96 cm



318 kg



> 80 %



55 cm



Standard



Zárt égéstér
Sealed Chamber



Visszahűtő
rendszer
/ Safety
system



0,09 %



14-16 PA



25
mg/Nm³



NERO
Standard



22 kW /
8 kW



200
flue base
construction
fűtőcsőnk
átmérő

PANAQUA

130 EVO LD



**GARANCIA
GUARANTEE**

Options
Opciók



Ajánlott Vermikulit béléssel
Option Vermiculite Linings



18-30 kW



74 l



126 cm



414 kg



> 80 %



70 cm



Standard



Zárt égéstér
Sealed Chamber



Visszahűtő
rendszer
/ Safety
system



0,09 %



14-16 PA



25
mg/Nm³



NERO
Standard



21 kW /
9 kW



200
flue base
construction
fűtőcsanak
átmérő

PANAQUA KÁLYHA / STOVE

EVO d160



Ajánlott Vermikulit béléssel
Option Vermiculite Linings



5-9 kW



195 kg



>86 %



35 cm



Standard



NERO
Standard



Zárt égéstér
Sealed
Chamber



Zárt rendszer
/ Closed
system



14-16 PA



7 kW /
2 kW

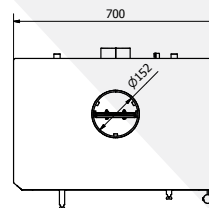
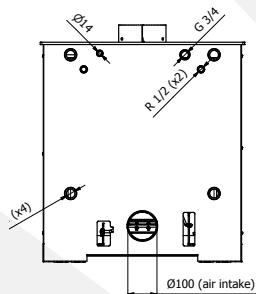
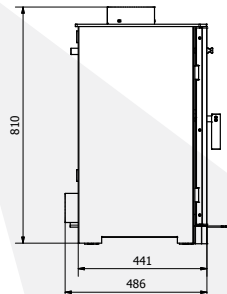
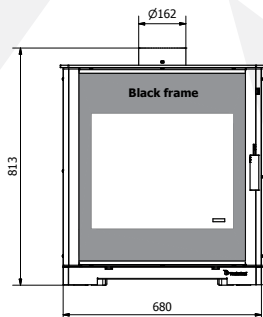

Ø160
flue base
construction
fűtcsanak
átmérő



PANTECH B

Tűztér család / Firebox family



Teljesítmény és hatások:

Az öntvény tűztereknél kisebb teljesítmény leadása mellett is kiváló hatásokkal tud működni. Zárt égésterű kivitel. Külső levegő ellátású levegő előmelegítő rendszerrel.

Élettartam:

4 mm-es falvastagságok, samott-vermikulit bélés, porleválasztó és lángterelő rendszer alkalmazása öntvény füstcsapantyúval. Magas szintű, hosszú fejlesztő mérnöki munka eredménye.

Design:

Diszkrét kezelőszervek, maximális üvegfelület, NERO üvegezés. Ez a tűztér már a jövő elvárásainak megfelelő technológiai fejlesztéssel készült.

Efficiency and performance:

Excellent efficiency even with less power output. Closed combustion chamber with external air supply preheating system. All of our Pantech B model designed as slow-burning insert.

Lifetime:

4 mm thick walls, chamotte-vermiculite inner lining, dust extraction and flame deflection system with cast iron smoke volume regulator.

Desing:

Big glass surfaces, modern, stunning design, practical output.

PANTECH B

Szerkezet
Structure



Füsttömeg szabályozás. Fontos a füsttömeg kiáramlásának torlasztása az égésidő és a hatásfok növelésének érdekében.

1 Regulation of the smoke crowd. To reach the improving burning time and the efficiency with the help of the blocking of the exhaust of the smoke is important

2 Secunder levegő, légfüggöny
Secondary air, air curtain

3 Hőálló bélés
Thermostable padding

4 Szintezőláb
Leveling feet

5 Légfüggöny szabályzókar
Air curtain control lever

6 Égési levegő szabályzókar
Combustion air control lever

 TECHNICAL

PANTECH

45 B CG

TÜV 15aB-VG BImSchV2.
CERTIFICATIONS



GARANCIA
GUARANTEE

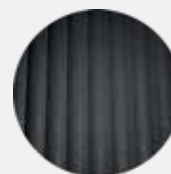

Vermikulit bélés
Vermiculite Linings



4-6 KW



45 cm



83 kg



> 80 %



25 cm



Standard



NERO
Standard



14-16 PA



Magasító
láb/
elevating
legs



150

flue base
construction
fűtőcsőnk
átmérő

PANTECH

60 B



**GARANCIA
GUARANTEE**



Szintező láb
Leveling foot



Zárt égéstér
Sealed
Chamber
standard



Vermikulit bélés
Vermiculite Linings



4-6 kW



58 cm



100 kg



> 80 %



33 cm



Standard



NERO
Standard



14-16 PA



Magasító
láb/
elevating
legs



150
flue base
construction
fűtőcsőnk
átmérő

 TECHNICAL

PANTECH

60 B CG L

TÜV 15aB-VG BImSchV2.
CERTIFICATIONS



GARANCIA
GUARANTEE



Vermikulit bélés
Vermiculite Linings



4-6 kW



58 cm



95 kg



> 80 %



33 cm



Standard



NERO
Standard



14-16 PA



Magasító
láb/
elevating
legs

~~150~~
flue base
construction
fűtőcsőnk
átmérő

 TECHNICAL

PANTECH

60 B CG R

TÜV 15aB-VG BImSchV2.
CERTIFICATIONS



GARANCIA
GUARANTEE



Vermikulit bélés
Vermiculite Linings



4-6 kW



58 cm



95 kg



> 80 %



33 cm



Standard



NERO
Standard



14-16 PA



Magasító
láb/
elevating
legs



150

flue base
construction
fűtőcsőnk
átmérő

 TECHNICAL

PANTECH

60 BU

TÜV 15aB-VG BImSchV2.
CERTIFICATIONS



GARANCIA
GUARANTEE



NERO
Standard

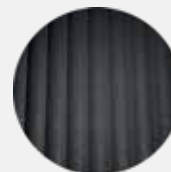

Vermikulit bélés
Vermiculite Linings



4-6 kW



58 cm



94 kg



> 80 %



30 cm



Zárt égéstér
Sealed
Chamber



Standard



14-16 PA



Magasító
láb/
elevating
legs



150
flue base
construction
fűtőcsanak
átmérő



GARANCIA
GUARANTEE

PANTECH

70 BU



NERO
Standard



Vermikulit bélés
Vermiculite Linings



4-7 kW



68 cm



109 kg



> 80 %



35 cm



Zárt égéstér
Sealed
Chamber



Standard



14-16 PA



Magasító
láb/
elevating
legs



200

flue base
construction
fűtőcsőnk
átmérő

PANTECH

68 B

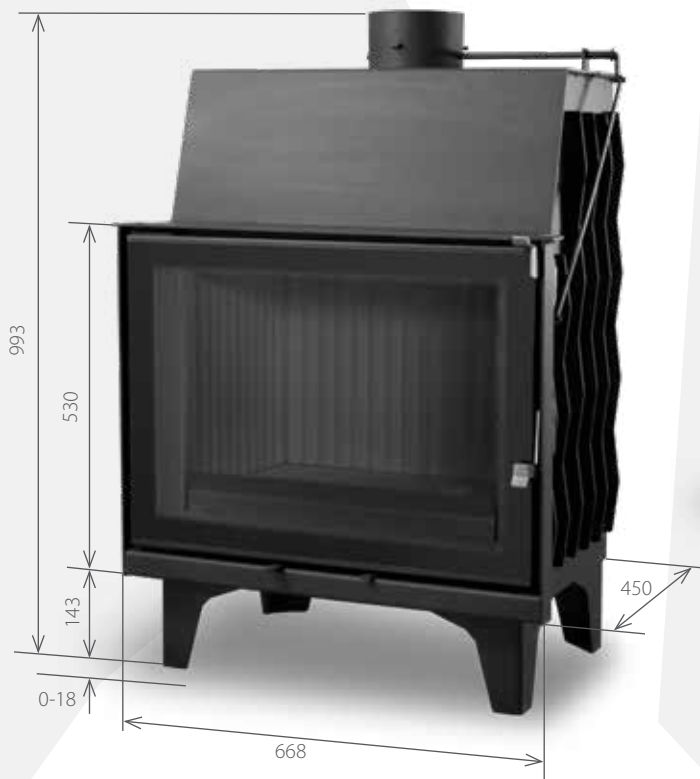

Szintező láb
Leveling foot

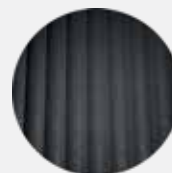

Vermikulit bélés
Vermiculite Linings



5-8 kW



68 cm



123 kg



> 80 %



40 cm



Zárt égéster
Sealed Chamber
standard



Standard



NERO
Standard



14-16 PA



Magasító
láb/
elevating
legs



 TECHNICAL

PANTECH

69 B CG L

TÜV 15aB-VG BImSchV2.
CERTIFICATIONS



GARANCIA
GUARANTEE



Vermikulit bélés
Vermiculite Linings



5-8 kW



69 cm



95 kg



> 80 %



33 cm



Standard



NERO
Standard



14-16 PA



Magasító
láb/
elevating
legs



150

flue base
construction
fűtőcsanak
átmérő



GARANCIA
GUARANTEE

PANTECH

69 B CG R



Vermikulit bélés
Vermiculite Linings



5-8 kW



69 cm



95 kg



> 80 %



33 cm



Standard



NERO
Standard



14-16 PA



Magasító
láb/
elevating
legs



150

flue base
construction
fűtőcső
átmérő

 TECHNICAL

PANTECH

75 B CG L

TÜV 15aB-VG BImSchV2.
CERTIFICATIONS



GARANCIA
GUARANTEE



Vermikulit bélés
Vermiculite Linings



200
flue base
construction
fűtcsanak
átmérő



5-9 kW



75 cm



125 kg



> 80 %



40 cm



Zárt égéstér
Sealed Chamber
standard



Standard



NERO
Standard



14-16 PA



Magasító
láb/
elevating
legs

PANTECH

75 B CG R



GARANCIA
GUARANTEE



Vermikulit bélés
Vermiculite Linings

 **200**
flue base
construction
fűtcsanak
átmérő



5-9 kW



75 cm



125 kg



> 80 %



40 cm



Zárt égéstér
Sealed Chamber
standard



Standard



NERO
Standard



14-16 PA



Magasító
láb/
elevating
legs

PANTECH

80 B



**GARANCIA
GUARANTEE**

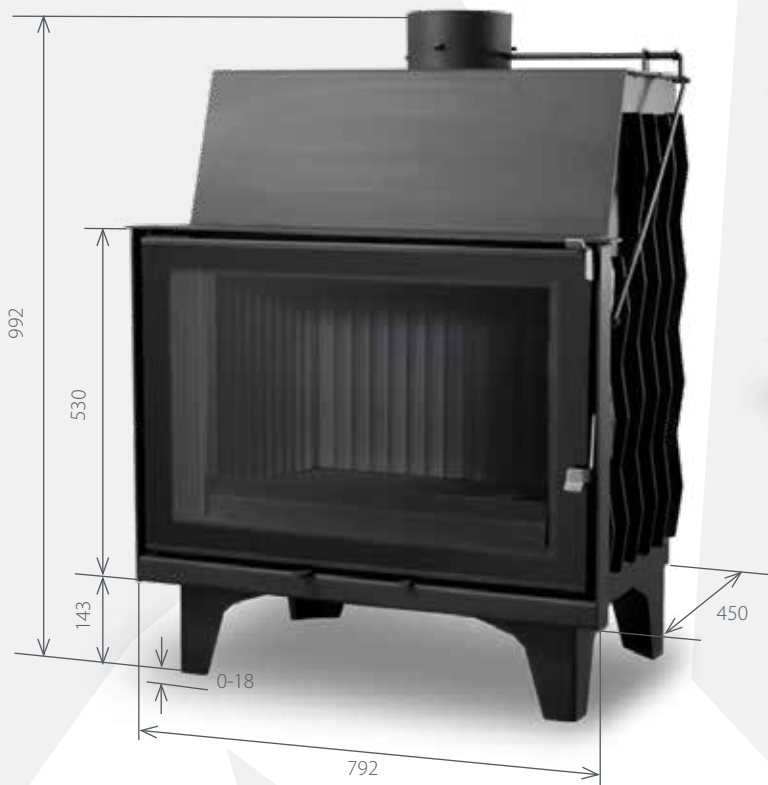

Vermikulit bélés
Vermiculite Linings

200
flue base
construction
fűtcsanak
átmérő



6-10 kW



80 cm



140 kg



> 80 %



55 cm



Zárt égéstér
Sealed Chamber
standard



Standard



NERO
Standard



14-16 PA



Magasító
láb/
elevating
legs

PanTech Mobil

NEW LINE



A Pantech Mobil készülékek fejlesztésénél alapvető szempontunk volt, hogy egy könnyen telepíthető, modern letisztult vonalú készülékeket tudjunk a vásárlóink részére biztosítani. Többféle formában, színben és méretben gyártjuk már ezeket. Alapvetően a PanTech B tűztér család tagjaival készülnek. Természetesen a hosszú élettartam és kiváló hatásfok könnyű kezelhetőség itt is biztosított a zárt rendszerű tűzterekkel.



GARANCIA
GUARANTEE

PANTECH

60 B MOBIL BLACK / WHITE 1+2



Vermikulit bélés
Vermiculite Linings



4-6 kW



70 cm



156 kg



> 80 %



30 cm



Zárt égéstér
Sealed
Chamber
standard



NERO
Standard



14-16 PA



Standard



150
flue base
construction
füstcsanak
átmérő



PANTECH

60 B MOBIL BLACK / WHITE 2+2

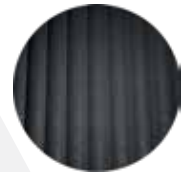

Vermikulit bélés
Vermiculite Linings



14-16 PA



Standard



4-6 kW



70 cm



171 kg



> 80 %



30 cm



Zárt égéstér
Sealed Chamber
standard



NERO
Standard



150
flue base
construction
fűtőcsanak
átmérő



PANTECH

60 B CG R MOBIL BLACK / WHITE 1+2

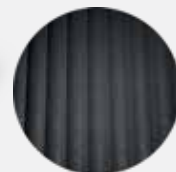

Vermikulit bélés
Vermiculite Linings



14-16 PA



Standard



4-6 kW



70 cm



150 kg



> 80 %



30 cm



Zárt égéstér
Sealed
Chamber
standard



NERO
Standard



150
flue base
construction
fűtőcsanak
átmérő



PANTECH

60 B CG R MOBIL BLACK / WHITE 2+2

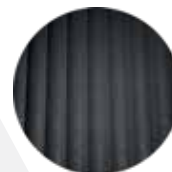

Vermikulit bélés
Vermiculite Linings



4-6 kW



70 cm



159 kg



> 80 %



30 cm



Zárt égéstér
Sealed Chamber
standard



NERO
Standard



14-16 PA



Standard



150
flue base
construction
fűtőcsanak
átmérő

PANTECH

60 B CG L MOBIL BLACK / WHITE 1+2

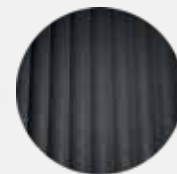

Vermikulit bélés
Vermiculite Linings



4-6 kW



70 cm



150 kg



> 80 %



30 cm



Zárt égéstér
Sealed
Chamber
standard



14-16 PA

Standard



NERO
Standard



150
flue base
construction
füstcsanak
átmérő

PANTECH

60 B CG L MOBIL BLACK / WHITE 2+2



Vermikulit bélés
Vermiculite Linings



4-6 kW



70 cm



159 kg



> 80 %



30 cm



Zárt égéstér
Sealed
Chamber
standard



14-16 PA



Standard



NERO
Standard



150
flue base
construction
fűtőcsanak
átmérő

PANTECH

60 B U MOBIL BLACK / WHITE 1+2

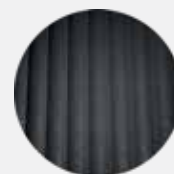

Vermikulit bélés
Vermiculite Linings



4-6 kW



57 cm



150 kg



> 80 %



30 cm



Standard



Zárt égéstér
Sealed
Chamber
standard



14-16 PA



150

flue base
construction
fűtőcsőnk
átmérő

PANTECH

60 B U MOBIL BLACK / WHITE 2+2



Vermikulit bélés
Vermiculite Linings



4-6 kW



57 cm



159 kg



> 80 %



30 cm



Standard



Zárt égéstér
Sealed
Chamber
standard



14-16 PA



150
flue base
construction
fűtőcsanak
átmérő





PANTECH JOY

Tűztér család / Firebox family



Teljesítmény és hatások:

A legújabb fejlesztésű tűztér családunk, melyet úgy terveztünk, hogy megfeleljen korunk elvárásainak, igényeinek és tökéletes élvezeti értéket nyújtson Önnek. Minden PanTech JOY készülék liftes ajtóval rendelkezik, mely egyszerű és elegáns kezelést tesz lehetővé, csökken a tűztér kifüstölési hajlama, ami rossz huzatviszonyok mellett rendkívül fontos. A modern NERO üvegezéssel éri el a lehető legnagyobb üvegfelületet. Zárt égésterű tűztér, utánégető rendszerrel, ami által szellőzőberendezésekkel egy légtérben is kiválóan működik.

Efficiency and performance:

Our brand new line of fireplaces, designed to meet the demands of our time and to give you the perfect enjoyment. All PanTech JOY units have premium lift door system that provides easy and elegant handling and reduce the tendency of the firebox to fumigate, which could be very important in poor draft conditions. The modern NERO glazing achieves the largest possible glass surface. The sealed combustion chamber and the afterburner system secures to working perfectly even with a ventilation equipment in the same space.

PANTECH JOY

Szerkezet / Structure



- 1 Secunder levegő, légfüggöny
Secondary air, air curtain
- 2 Harmadlagos levegő
Tertiary air
- 3 Szintezőláb
Leveling feet
- 4 Légfüggöny szabályzókar
Air curtain control lever
- 5 Égési levegő szabályzókar
Combustion air control lever
- 6 Hőálló bélés
Thermostable padding

 TECHNICAL

PANTECH

80 JOY CG LD L

TÜV 15aB-VG BImSchV2.
CERTIFICATIONS



GARANCIA
GUARANTEE



4-7 kW



80 cm



217 kg



> 80 %



35 cm



Zárt égéstér
Sealed
Chamber



0,09 %



12-16 PA



NERO
Standard



Standard

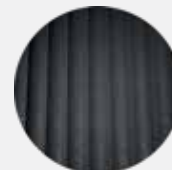

Vermikulit bélés
Vermiculite Linings



200
flue base
construction
fűtőcsanak
átmérő

PANTECH

80 JOY CG LD R



**GARANCIA
GUARANTEE**

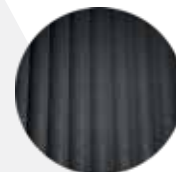

Vermikulit bélés
Vermiculite Linings



4-7 kW



80 cm



217 kg



> 80 %



35 cm



Zárt égéstér
Sealed
Chamber
standard



0,09 %



12-16 PA



NERO
Standard



Standard



200
flue base
construction
fűtőcsanak
átmérő



**GARANCIA
GUARANTEE**

PANTECH

80 JOY U LD



4-7 kW



80 cm



203 kg



> 80 %



35 cm



Zárt égéstér
Sealed
Chamber



0,09 %



12-16 PA



NERO
Standard



Standard

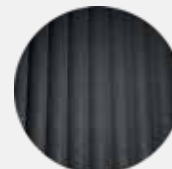

Vermikulit bélés
Vermiculite Linings



200
flue base
construction
fűtőcsanak
átmérő



GARANCIA
GUARANTEE

PANTECH

80 JOY V LD



4-7 kW



80 cm



256 kg



> 80 %



45-50 cm



Zárt égéstér
Sealed
Chamber



0,09 %



12-16 PA



NERO
Standard



Standard

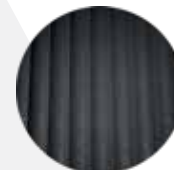

Vermikulit bélés
Vermiculite Linings



200
flue base
construction
fűtőcsanak
átmérő

PANTECH

100 JOY LD

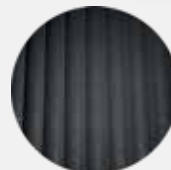

Vermikulit bélés
Vermiculite Linings



4-7 kW



100 cm



210 kg



> 80 %



45-50 cm



Zárt égéstér
Sealed
Chamber
standard



0,09 %



12-16 PA



NERO
Standard



Standard



200
flue base
construction
fűtőcsanak
átmérő



PANTECH

Tűztér család / Firebox family



Teljesítmény és hatások:

Nagy hőleadó felületek, 3-5 darab bordázott hőcsatorna, másodlagos és harmadlagos levegőellátás, teljesen zárt égéstér, alapkivitelben külső levegő ellátás és levegő előmelegítő rendszerrel.

Élettartam:

4-5 mm-es falvastagságok, Accutech bélés, porleválasztó és lángterelő rendszer alkalmazása öntvény füstcsappantyúval. Magas szintű, hosszú fejlesztő mérnöki munka eredménye.

Design:

Diszkrét kezelőszervek, maximális üvegfelület, NERO üvegezés. Ez a tűztér már a jövő elvárásainak megfelelő technológiai fejlesztéssel készült.

Efficiency and performance:

Big heat dissipation surfaces, 3-5 ribbed heat channels, secondary and tertiary air supply, completely closed combustion chamber, external air supply and air preheater system.

Lifetime:

The 4 to 5 mm thick walls, fire-brick and Accutech lining, dust separator and baffle system with molding flap are all the result of high quality and long engineering.

Desing:

Unobtrusive handles, big glass surfaces, NERO glasses. This firebox was made by using the innovation that meets the requirements of the future.

PANTECH EVO PREMIUM

Szerkezet / Structure



- 1 Füsttömeg szabályozás. Fontos a füsttömeg kiáramlásának torlasztása az égésidő és a hatásfok növelésének érdekében.
Regulation of the smoke crowd. To reach the improving burning time and the efficiency with the help of the blocking of the exhaust of the smoke is important
- 2 Hócsatorna
Heating channel
- 3 Secunder levegő, légfüggöny
Secondary air, air curtain
- 4 Utánégető
Afterburner
- 5 Rostély
Grate
- 6 Hamuláda
Ash box
- 7 Hóálló bélés
Thermostable padding
- 8 Szintező láb
Leveling foot
- 9 Levegő szabályzókar
Air controlling lever



**GARANCIA
GUARANTEE**



Standard Accutech
bélés / Linings



7-13 kW



68 cm



179 kg



> 80 %



> 84 %



40 cm



Zárt égéstér
Sealed
Chamber



Standard



0,09 %



12-16 PA



25
mg/Nm³



NERO
Standard

200
flue base
construction
fűtcsónk
átmérő

150
flue can be
ordered
választható
fűtcsónk
átmérő

PANTECH
68 EVO TUNNEL

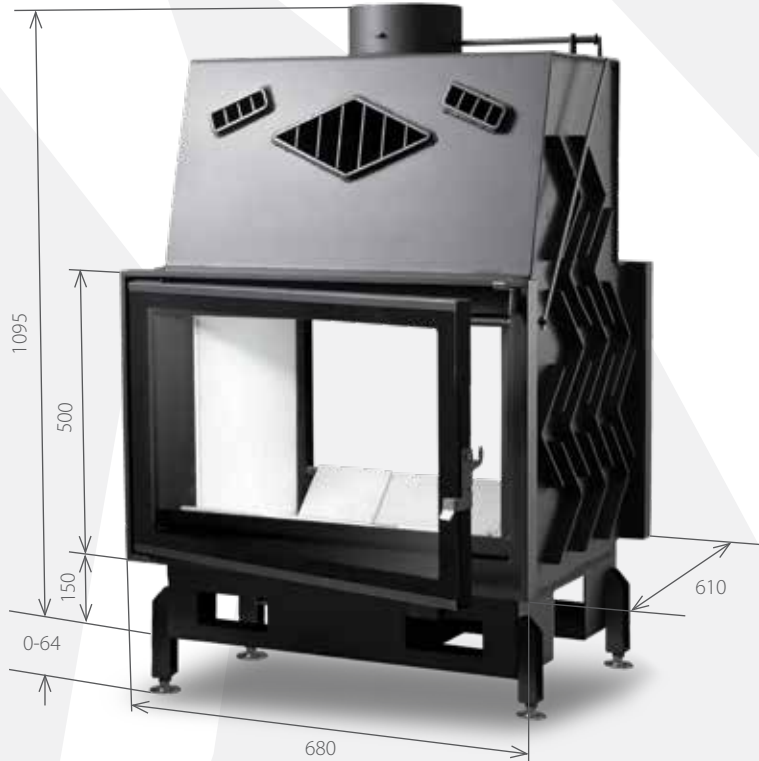

Standard Accutech
bélés / Linings

- | | | | | | |
|--|-----------------|---------------|------------------|---------------------------------|--------------------------|
| kW
7-13 kW | 68 cm | 204 kg | > 80 % | > 84 % | 40 cm |
| Zárt égéster
Sealed
Chamber | Standard | 0,09 % | 12-16 PA | 25
mg/Nm³ | NERO
Standard |

200
flue base
construction
füstcsónk
átmérő

 TECHNICAL

PANTECH

80 EVO

TÜV 15aB-VG BImSchV2.
CERTIFICATIONS



GARANCIA
GUARANTEE



Standard Accutech
bélés / Linings



10-17 kW



80 cm



204 kg



> 80 %



> 84 %



55 cm



Zárt égéstér
Sealed
Chamber



Standard



0,09 %



12-16 PA



25
mg/Nm³



NERO
Standard



200
flue base
construction
fűtőcsanak
átmérő

PANTECH

80 EVO TUNNEL



Standard Accutech
bélés / Linings



10-17 kW



80 cm



230 kg



> 80 %



> 84 %



55 cm



Zárt égéstér
Sealed
Chamber



Standard



0,09 %



12-16 PA



25
mg/Nm³



NERO
Standard

 **200**
flue base
construction
fűtőcsanak
átmérő

PANTECH

80 EVO LD



**GARANCIA
GUARANTEE**



Standard Accutech
bélés / Linings



8-14 kW



80 cm



230 kg



> 80 %



> 84 %



40 cm



Zárt égéstér
Sealed
Chamber



Standard



0,09 %



12-16 PA



25
mg/Nm³



NERO
Standard

200
flue base
construction
fűtcsanak
átmérő

PANTECH

80 EVO LD TUNNEL



TUNNEL/2 ajtós kivitel



Standard Accutech
bélés / Linings



6-12 kW



80cm



310 kg



> 80 %



> 84 %



40 cm



Zárt égéster
Sealed
Chamber



Standard



0,1 %



12-16 PA



25
mg/Nm³



NERO
Standard

200
flue base
construction
füstcsanak
átmérő

PANTECH

90 EVO CG LD L



**GARANCIA
GUARANTEE**



Standard Accutech
bélés / Linings



8-14 kW



89 cm



280 kg



> 80 %



> 84 %



55 cm



Zárt égéstér
Sealed
Chamber



Standard



0,09 %



12-16 PA



25
mg/Nm³



NERO
Standard

200
flue base
construction
fűtőcsanak
átmérő



**GARANCIA
GUARANTEE**

PANTECH

90 EVO CG LD R



Standard Accutech
bélés / Linings



8-14 kW



89 cm



280 kg



> 80 %



> 84 %



55 cm



Zárt égéstér
Sealed
Chamber



Standard



0,09 %



12-16 PA



25
mg/Nm³



NERO
Standard

200
flue base
construction
füstcsonk
átmérő

PANTECH

100 EVO LD



**GARANCIA
GUARANTEE**



Standard Accutech
bélés / Linings



10-17 kW



96 cm



260 kg



> 80 %



> 84 %



55 cm



Zárt égéstér
Sealed
Chamber



Standard



0,09 %



12-16 PA



25
mg/Nm³



NERO
Standard

200
flue base
construction
fűtcsanak
átmérő



TUNNEL/2 ajtós kivitel



Standard Accutech
bélés / Linings



8-14 kW



93 cm



356 kg



> 80 %



> 84 %



55 cm



Zárt égéstér
Sealed
Chamber



Standard



0,1 %



12-16 PA



25
mg/Nm³



NERO
Standard

200
flue base
construction
füstcsonk
átmérő



**GARANCIA
GUARANTEE**



Standard Accutech
bélés / Linings



8-14 kW



99 cm



302 kg



> 80 %



> 84 %



55 cm



Zárt égéstér
Sealed
Chamber



Standard



0,1 %



12-16 PA



25
mg/Nm³



NERO
Standard

200
flue base
construction
fűtőcsanak
átmérő

PANTECH

100 EVO V LD



**GARANCIA
GUARANTEE**



Standard Accutech
bélés / Linings



8-14 kW



66 cm



389 kg



> 80 %



> 84 %



55 cm



Zárt égéstér
Sealed
Chamber



Standard



0,1 %



12-16 PA



25
mg/Nm³



NERO
Standard



200
flue base
construction
fűtcsonk
átmérő



PANTECH

110 EVO

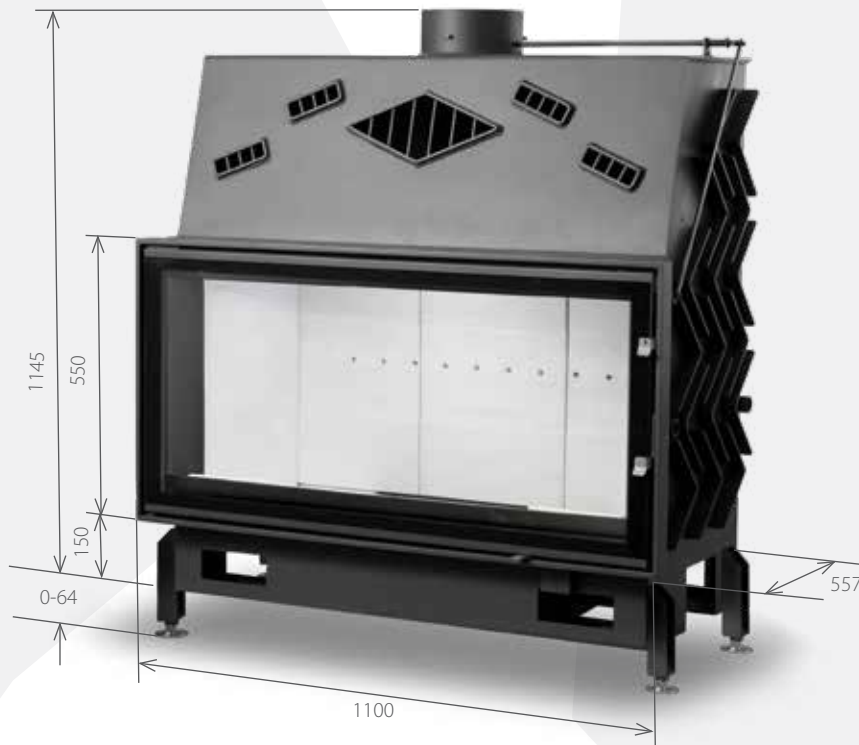

Standard Accutech
bélés / Linings



12-21 kW



110 cm



288 kg



> 80 %



> 84 %



70 cm



Zárt égéstér
Sealed
Chamber



Standard



0,09 %



12-16 PA



25
mg/Nm³



NERO
Standard

200
flue base
construction
fűtcsanak
átmérő

PANTECH
110 EVO TUNNEL



Standard Accutech
bélés / Linings



12-21 kW



110 cm



313 kg



> 80 %



> 84 %



70 cm



Zárt égéstér
Sealed
Chamber



Standard



0,09 %



12-16 PA



25
mg/Nm³



NERO
Standard

200
flue base
construction
füstcsanak
átmérő



**GARANCIA
GUARANTEE**

PANTECH

130 EVO LD



Standard Accutech
bélés / Linings



12-21 kW



126 cm



335 kg



> 80 %



> 84 %



70 cm



Zárt égéstér
Sealed
Chamber



Standard



0,09 %



12-16 PA



25
mg/Nm³



NERO
Standard



200
flue base
construction
fűtcsanak
átmérő

PANTECH

130 EVO LD TUNNEL



TUNNEL / 2 ajtó kivitel



Standard Accutech
bélés / Linings



8-14 kW



126 cm



479 kg



> 80 %



> 84 %



70 cm



Zárt égéstér
Sealed
Chamber



Standard



0,1 %



12-16 PA



25
mg/Nm³



NERO
Standard

 **200**
flue base
construction
füstcsanak
átmérő

 **TECHNICAL**

PANTECH

160 EVO LD

TÜV 15aB-VG **BlmSchV2.**
CERTIFICATIONS



**GARANCIA
GUARANTEE**

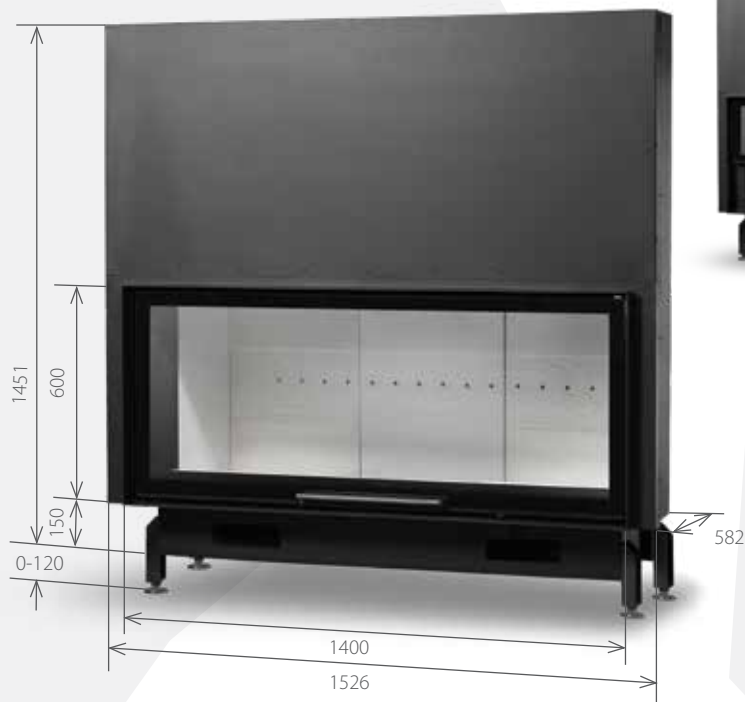

Standard Accutech
bélés / Linings



12-21 kW



153 cm



437 kg



> 80 %



> 84 %



70 cm



Zárt égéstér
Sealed
Chamber



Standard



0,09 %



12-16 PA



25
mg/Nm³



NERO
Standard

 **250**
flue base
construction
fűtcsanak
átmérő



**GARANCIA
GUARANTEE**

PANTECH

200 EVO LD



Standard Accutech
bélés / Linings



12-21 kW



193 cm



560 kg



> 80 %



> 84 %



70 cm



Zárt égéstér
Sealed
Chamber



Standard



0,09 %



12-16 PA



25
mg/Nm³



NERO
Standard

300
flue base
construction
fűtcsonk
átmérő

PANTECH

CLASSIC 95



9-15 kW



95 cm



120 kg



73 %



78 %



55 cm



Option



Lábazat
/ Legs
Option



Zárt égéstér
Sealed
Chamber
standard



14-16 PA

 **200**
flue base
construction
fűtcsanak
átmérő



Vermikulit bélés
Vermiculite Linings

PANTECH

CLASSIC 110



11-19 kW



110 cm



140 kg



73 %



78 %



70 cm



Option



Lábazat
/ Legs
Option



Zárt égéstér
Sealed
Chamber
Standard



14-16 PA



200
flue base
construction
fűtőcsanak
átmérő

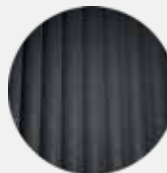

Vermikulit bélés
Vermiculite Linings

PANBOX

68



**GARANCIA
GUARANTEE**



Zárt égéstér
Sealed
Chamber

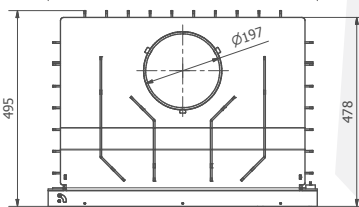
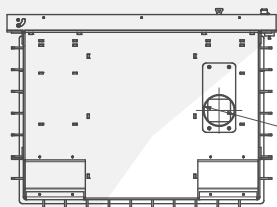

4-7 kW



104 kg



Standard



> 76 %



50 cm



14-16 PA

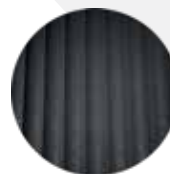
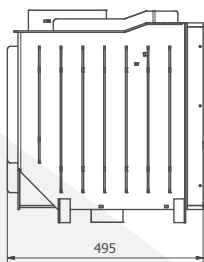
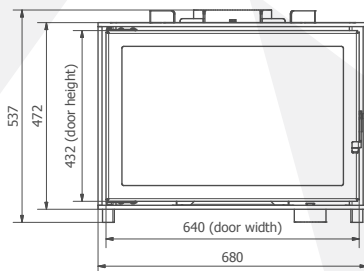

Vermikulit bélés
Vermiculite Linings



200
flue base
construction
fűtőcsőnk
átmérő

 TECHNICAL

PANBOX

110



GARANCIA
GUARANTEE



Zárt égéstér
Sealed
Chamber



Vermikulit bélés
Vermiculite Linings

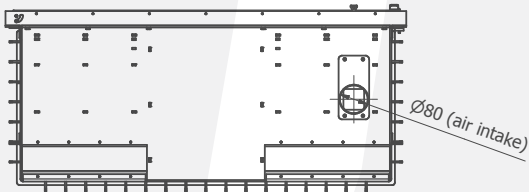

4-8 kW



173 kg



Standard



> 76 %



70 cm



14-16 PA

 **200**
flue base
construction
füstcsanak
átmérő

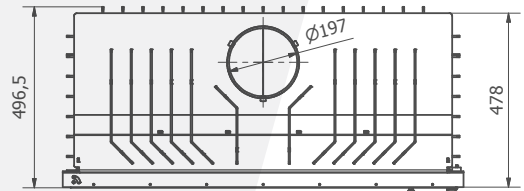
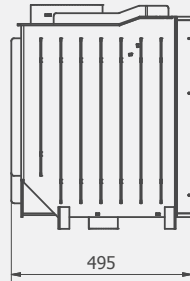
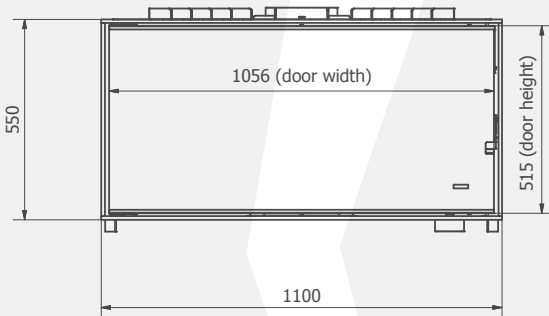

ELEKTROMOS TŰZTEREK ELECTRIC FIREPLACES



További széles választékú elektromos és bioetanolos tűztér kínálatunkról weboldalunkon tud tájékozódni.
You can find more about our wide range of electric and bioethanol fireplaces on our website.

HŐDOBOK

Heat reclaimers



A lemezházás és az öntöttvas légfűtő tűzterek kiegészítő eleme. Alkalmazásával megnöveljük a hőleadó felületet és alacsonyabb hőmérsékleten tudjuk a füstgázt a kéménybe kibocsátani, ezzel hatásfok- és teljesítménynövelést érünk el. A hődob különlegessége az emelkedéssel elhelyezett hőleadó cső, melyek a fokozott konvekciós légáramlás növekedését segítik elő.

It is the supplementary element of disk-based and cast-iron fireboxes. It raises the heat dissipation surfaces and emits the exhaust fumes to the chimney at a lower temperature, with a help of this, higher efficiency and performance can be reached. The specialty of the heat reclaimer is the tube that assures increased convection to your living space.

HŐDOB / HEAT RECLAIMER

150



3-4,5 KW



16 Kg

HŐDOB / HEAT RECLAIMER

200



4-6 kW



23 Kg

VIZES HŐDOB / WATER HEAT RECLAIMER

MINI, MAXI

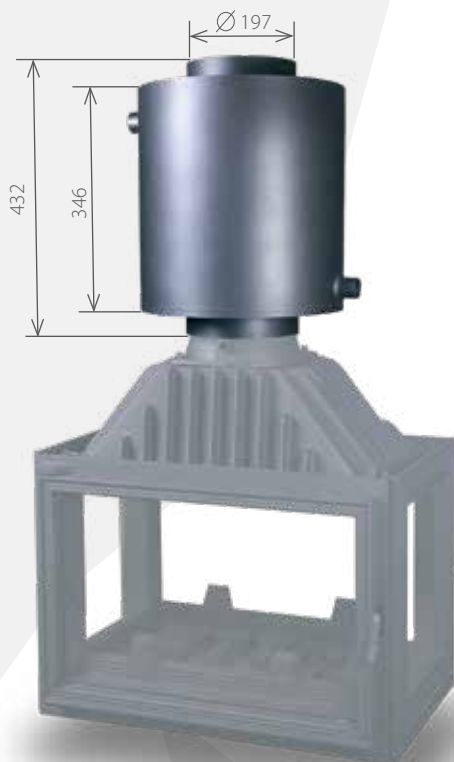

4-5 KW



13,5 L



27 Kg



7-10 KW



23,5 L



41 Kg



KIEGÉSZÍTŐK

SZELLŐZŐRÁCSOK / ACCESSORIES



Vörösréz
kandalló
szellőzőrács
17x17
Zsalus: 17x17



Vörösréz , zsalus
kandalló
szellőzőrács
17x17



Fehér
kandalló
szellőzőrács
17x17



Fehér, zsalus
kandalló
szellőzőrács
Zsalus: 17x17



Krém
kandalló
szellőzőrács
17x17



Krém, zsalus
kandalló
szellőzőrács
Zsalus: 17x17

KIEGÉSZÍTŐK

SZELLŐZŐRÁCSOK / ACCESSORIES



Acél
kandalló
szellőzőrács
17x17



Acél, zsalus
kandalló
szellőzőrács
17x17



Króm
kandalló
szellőzőrács
17x17



Króm, zsalus
kandalló
szellőzőrács
Zsalus: 17x17



Rusztikus
kandalló
szellőzőrács
17x17



Rusztikus, zsalus
kandalló
szellőzőrács
Zsalus: 17x17



Antracit
kandalló
szellőzőrács
17x17



Antracit, zsalus
kandalló
szellőzőrács
Zsalus: 17x17

A mindenkori készletről kérjük érdeklődjön a bemutatótermünkben.
Please inquire about the current stock in our showroom.

KIEGÉSZÍTŐK

SZELLŐZŐRÁCSOK / ACCESSORIES



Vörösréz kandalló
szellőzőrács
17x30



Vörösréz zsalus
kandalló szellőzőrács
Zsalus: 17x30



Króm kandalló
szellőzőrács
17x30



Króm kandalló
szellőzőrács
Zsalus: 17x30



Acél zsalus
kandalló szellőzőrács
Zsalus: 17x30



Króm zsalus
kandalló szellőzőrács
17x30



Rusztikus zsalus
kandalló szellőzőrács
Zsalus: 17x30



Antracit kandalló
szellőzőrács
17x30



Antracit zsalus
kandalló
szellőzőrács

17x30



Krém kandalló
szellőzőrács
17x30



Krém kandalló
szellőzőrács
17x49



Fehér kandalló
szellőzőrács
17x49

A mindenkor készletről kérjük érdeklődjön a bemutatótermünkben.
Please inquire about the current stock in our showroom.

KIEGÉSZÍTŐK

SZELLŐZŐRÁCSOK / ACCESSORIES



Regia 2
kandalló szellőzőrács



Regia 3
kandalló szellőzőrács



Regia 4
kandalló szellőzőrács



Regia 5
kandalló szellőzőrács



Króm kandalló
szellőzőrács
17x49



Vörösréz kandalló
szellőzőrács
17x49



Rusztikus kandalló
szellőzőrács
17x49



Antracit kandalló
szellőzőrács
17x49



Vertical



Duplo



Trio



Alba kandalló
szellőzőrács



Budapesti Bemutatóterem
Budapest showroom

1103 Budapest X. Kőér u. /str. 16.
Tel. / Phone: +36 (1) 260 2290
Mobil / Phone: +36 (20) 341 1217

Forgalmazó / Distributor

WWW.TECHNICAL.HU

© 2021 Technical tüzeléstechnika